



**SMART SOUNDBAR 900**

## Please read and keep all safety, security, and use instructions.

**CE** Bose Corporation hereby declares that this product is in compliance with the essential requirements and other relevant provisions of Directive 2014/53/EU and all other applicable EU directive requirements. The complete declaration of conformity can be found at: [www.Bose.com/compliance](http://www.Bose.com/compliance)

**UK  
CA** This product conforms to all applicable Electromagnetic Compatibility Regulations 2016 and all other applicable UK regulations. The complete declaration of conformity can be found at: [www.Bose.com/compliance](http://www.Bose.com/compliance)

Bose Corporation hereby declares that this product is in compliance with the essential requirements per Radio Equipment Regulations 2017 and all other applicable UK regulations. The complete declaration of conformity can be found at: [www.Bose.com/compliance](http://www.Bose.com/compliance)

## Important Safety Instructions

Read these instructions.

Clean only with a dry cloth.

Do not block any ventilation openings. Install in accordance with the manufacturer's instructions.

Do not install near any heat sources such as radiators, heat registers, stoves, or other apparatus (including amplifiers) that produce heat.

Only use attachments/accessories specified by the manufacturer.

Refer all servicing to qualified personnel. Servicing is required when the apparatus has been damaged in any way, such as power-supply cord or plug is damaged, liquid has been spilled or objects have fallen into the apparatus, the apparatus has been exposed to rain or moisture, does not operate normally, or has been dropped.

## WARNINGS/CAUTIONS



This symbol on the product means there is uninsulated, dangerous voltage within the product enclosure that may present a risk of electrical shock.



This symbol on the product means there are important operating and maintenance instructions in this guide.



Contains small parts which may be a choking hazard. Not suitable for children under age 3.



This product contains magnetic material. Consult your physician on whether this might affect your implantable medical device.



This product contains a tempered glass surface. Use caution to avoid impact. In the event of breakage, use care in handling broken glass.

- To reduce the risk of fire or electrical shock, do NOT expose this product to rain, liquids or moisture.
- Do NOT expose this product to dripping or splashing, and do not place objects filled with liquids, such as vases, on or near the product.
- Keep the product away from fire and heat sources. Do NOT place naked flame sources, such as lighted candles, on or near the product.
- Do NOT make unauthorized alterations to this product.
- Do NOT use a power inverter with this product.
- Do NOT use in vehicles or boats.
- Where the mains plug or an appliance coupler is used as the disconnect device, the disconnect device shall remain readily operable.
- Only use the following hardware to mount this product: Bose Soundbar Wall Bracket.
- When positioning the product, make sure it is not blocking any ventilation openings on your TV or monitor. Refer to the owner's guide that came with your TV or monitor and install in accordance with the manufacturer's instructions.
- Due to ventilation requirements, Bose does not recommend placing the product in a confined space such as in a wall cavity or in an enclosed cabinet.
- Keep batteries out of reach of children.
- Batteries may cause a fire or chemical burn if mishandled. Do not recharge, disassemble, heat, or incinerate.

**NOTE:** This equipment has been tested and found to comply with the limits for a Class B digital device, pursuant to Part 15 of the FCC Rules. These limits are designed to provide reasonable protection against harmful interference in a residential installation. This equipment generates, uses, and can radiate radio frequency energy and, if not installed and used in accordance with the instructions, may cause harmful interference to radio communications. However, there is no guarantee that interference will not occur in a particular installation. If this equipment does cause harmful interference to radio or television reception, which can be determined by turning the equipment off and on, the user is encouraged to try to correct the interference by one or more of the following measures:

- Reorient or relocate the receiving antenna.
- Increase the separation between the equipment and receiver.
- Connect the equipment into an outlet on a circuit different from that to which the receiver is connected.
- Consult the dealer or an experienced radio/TV technician for help.

Changes or modifications not expressly approved by Bose Corporation could void the user’s authority to operate this equipment.

This device complies with part 15 of the FCC Rules and with ISED Canada license-exempt RSS standard(s). Operation is subject to the following two conditions: (1) This device may not cause harmful interference, and (2) this device must accept any interference received, including interference that may cause undesired operation.

This equipment should be installed and operated with a minimum distance of 20 cm between radiator and your body.

This device for operation in the band 5150 – 5250 MHz is only for indoor use to reduce the potential for harmful interference to other co-channel mobile satellite systems.

**CAN ICES-3(B)/NMB-3(B)**

**Product Power State Table**

The product, in accordance with the Ecodesign Requirements for Energy Related Products Directive 2009/125/EC and the Ecodesign for Energy-Related Products and Energy Information (Amendment) (EU Exit) Regulations 2020, is in compliance with the following norm(s) or document(s): Regulation (EC) No. 1275/2008, as amended by Regulation (EU) No. 801/2013.

Required Power State Information	Power Modes	
	Standby	Networked Standby
Power consumption in specified power mode, at 230V/50Hz input	< 0.5 W	all network types ≤ 2.0 W
Time after which equipment is automatically switched into mode	< 2.5 hours	≤ 20 minutes
Power consumption in networked standby if all wired network ports are connected and all wireless network ports are activated, at 230V/50Hz input	N/A	≤ 2.0 W
Network port deactivation/activation procedures. Deactivating all networks will enable standby mode.	<p><b>Wi-Fi®:</b> Deactivate by pressing and holding the Bose Music and Skip Forward buttons on the remote simultaneously. Repeat to activate.</p> <p><b>Bluetooth®:</b> Deactivate by clearing the pairing list by pressing and holding the <i>Bluetooth®</i> button on the remote for 10 seconds. Activate by pairing with a <i>Bluetooth®</i> source.</p> <p><b>Ethernet:</b> Deactivate by removing the Ethernet cable. Activate by inserting the Ethernet cable.</p>	

**For Europe:**

Frequency bands of operation 2400 to 2483.5 MHz, 5150 to 5350 MHz, and 5470 to 5725 MHz.

Maximum transmit power less than 20 dBm EIRP.

Frequency band of operation 5725 to 5850 MHz.

Maximum transmit power less than 14 dBm (25mW) EIRP.

Maximum transmit power is below regulatory limits such that SAR testing is not necessary and exempt per applicable regulations.

This device is restricted to indoor use when operating in the 5150 to 5350 MHz frequency range in all EU Member States listed in the table.

									
BE	DK	IE	UK(NI)	FR	CY	SK	HU	AT	SE
BG	DE	PT	EL	HR	LV	LT	MT	PL	
CZ	EE	FI	ES	IT	RO	LU	NL	SI	



This symbol means the product must not be discarded as household waste, and should be delivered to an appropriate collection facility for recycling. Proper disposal and recycling helps protect natural resources, human health and the environment. For more information on disposal and recycling of this product, contact your local municipality, disposal service, or the shop where you bought this product.

**Management Regulation for Low-power Radio-frequency Devices**

**Article XII**

According to “Management Regulation for Low-power Radio-frequency Devices” without permission granted by the NCC, any company, enterprise, or user is not allowed to change frequency, enhance transmitting power or alter original characteristic as well as performance to an approved low power radio-frequency devices.

**Article XIV**

The low power radio-frequency devices shall not influence aircraft security and interfere legal communications; If found, the user shall cease operating immediately until no interference is achieved. The said legal communications means radio communications operated in compliance with the Telecommunications Act.

The low power radio-frequency devices must be susceptible with the interference from legal communications or ISM radio wave radiated devices.



**Please dispose of used batteries properly, following local regulations.** Do not incinerate.

### China Restriction of Hazardous Substances Table

Names and Contents of Toxic or Hazardous Substances or Elements						
Toxic or Hazardous Substances and Elements						
Part Name	Lead (Pb)	Mercury (Hg)	Cadmium (Cd)	Hexavalent (CR(VI))	Polybrominated Biphenyl (PBB)	Polybrominated diphenylether (PBDE)
PCBs	X	0	0	0	0	0
Metal Parts	X	0	0	0	0	0
Plastic Parts	0	0	0	0	0	0
Speakers	X	0	0	0	0	0
Cables	X	0	0	0	0	0
This table is prepared in accordance with the provisions of SJ/T 11364. O: Indicates that this toxic or hazardous substance contained in all of the homogeneous materials for this part is below the limit requirement of GB/T 26572. X: Indicates that this toxic or hazardous substance contained in at least one of the homogeneous materials used for this part is above the limit requirement of GB/T 26572.						

### Taiwan Restriction of Hazardous Substances Table

Equipment name: Powered Speaker, Type designation: 433829						
Restricted substances and its chemical symbols						
Unit	Lead (Pb)	Mercury (Hg)	Cadmium (Cd)	Hexavalent chromium (Cr+6)	Polybrominated biphenyls (PBB)	Polybrominated diphenyl ethers (PBDE)
PCBs	-	o	o	o	o	o
Metal Parts	-	o	o	o	o	o
Plastic Parts	o	o	o	o	o	o
Speakers	-	o	o	o	o	o
Cables	-	o	o	o	o	o
<b>Note 1:</b> "o" indicates that the percentage content of the restricted substance does not exceed the percentage of reference value of presence. <b>Note 2:</b> The "-" indicates that the restricted substance corresponds to the exemption.						

**Date of Manufacture:** The eighth digit in the serial number indicates the year of manufacture; “1” is 2011 or 2021.

**China Importer:** Bose Electronics (Shanghai) Company Limited, Level 6, Tower D, No. 2337 Gudai Rd. Minhang District, Shanghai 201100

**EU Importer:** Bose Products B.V., Gorslaan 60, 1441 RG Purmerend, The Netherlands

**Taiwan Importer:** Bose Taiwan Branch, 9F-A1, No. 10, Section 3, Minsheng East Road, Taipei City 104, Taiwan  
Phone Number: +886-2-2514 7676

**Mexico Importer:** Bose de México, S. de R.L. de C.V., Paseo de las Palmas 405-204, Lomas de Chapultepec, 11000 México, D.F. Phone Number: +5255 (5202) 3545

**UK Importer:** Bose Limited, Bose House, Quayside Chatham Maritime, Chatham, Kent, ME4 4QZ, United Kingdom

**Input Rating:** 100 - 240V ~ 50/60Hz, 65W

The CMIIT ID is located on the product label on the back of the soundbar.

### Please complete and retain for your records

The serial and model numbers are located on the back of the soundbar.

Serial number: \_\_\_\_\_

Model number: 433829

Please keep your receipt with your owner's guide. Now is a good time to register your Bose product. You can easily do this by going to [global.bose.com/register](https://global.bose.com/register)

### Security Information



This product is capable of receiving automatic security updates from Bose. To receive automatic security updates, you must complete the product setup process in the Bose Music app and connect the product to the Internet. **If you do not complete the setup process, you will be responsible for installing security updates that Bose makes available.**

Amazon, Alexa, Amazon Music, and all related logos are trademarks of Amazon.com, Inc. or its affiliates.

Apple, the Apple logo, Apple Music, and AirPlay are trademarks of Apple Inc., registered in the U.S. and other countries. App Store is a service mark of Apple Inc.

Use of the Works with Apple badge means that an accessory has been designed to work specifically with the technology identified in the badge and has been certified by the developer to meet Apple performance standards.

The *Bluetooth*<sup>®</sup> word mark and logos are registered trademarks owned by Bluetooth SIG, Inc. and any use of such marks by Bose Corporation is under license.

 Dolby, Dolby Atmos, and the double-D symbol are registered trademarks of Dolby Laboratories Licensing Corporation. Manufactured under license from Dolby Laboratories. Confidential unpublished works. Copyright © 2012-2020 Dolby Laboratories. All rights reserved.

Google and Google Play are trademarks of Google LLC.

 The terms HDMI, HDMI High-Definition Multimedia Interface, and the HDMI logo are trademarks or registered trademarks of HDMI Licensing Administrator, Inc.

This product contains the iHeartRadio service. iHeartRadio is a registered trademark of iHeartMedia, Inc.

This product is protected by certain intellectual property rights of Microsoft. Use or distribution of such technology outside of this product is prohibited without a license from Microsoft.

Pandora is a trademark or registered trademark of Pandora Media, Inc. used with permission.

QuickSet is a registered trademark of Universal Electronics Inc. in the United States and Internationally.  
© UEI 2000-2021

This product incorporates Spotify software which is subject to third-party licenses found here:  
[www.spotify.com/connect/third-party-licenses](http://www.spotify.com/connect/third-party-licenses)

Spotify is a registered trademark of Spotify AB.

Wi-Fi is a registered trademark of Wi-Fi Alliance<sup>®</sup>.



ADAPTiQ, Bose, Bose Bass Module, Bose Music, the Bose Music logo, Bose Noise Cancelling Headphones, Bose Smart Soundbar, Bose Soundbar Wall Bracket, Bose Surround Speakers, QuietComfort, SimpleSync, SoundLink, SoundLink Revolve, and Voice4Video are trademarks of Bose Corporation.

Bose Corporation Headquarters: 1-877-230-5639

©2021 Bose Corporation. No part of this work may be reproduced, modified, distributed, or otherwise used without prior written permission.



To view the license disclosures that apply to the third-party software packages included as components of your Bose Smart Soundbar 900 product:

1. On the remote, press and hold the *Bluetooth* button  and Skip backward button  for 5 seconds.
2. Connect a USB cable to the SERVICE connector on the back of the soundbar.
3. Connect the other end of the cable to a computer.
4. On the computer, enter <http://203.0.113.1/opensource> in a browser window to display the EULA and license disclosure.

**WHAT'S IN THE BOX**

Contents ..... 14

**DOLBY ATMOS® TECHNOLOGY** ..... 15

**SOUNDBAR PLACEMENT**

Recommendations..... 16  
 Wall mount the soundbar ..... 17  
     Adjust audio for wall mounting..... 17

**SET UP THE SOUNDBAR**

Connect the soundbar to power..... 18  
 Network standby..... 18

**BOSE MUSIC APP SETUP**

Download the Bose Music app..... 19

**EXISTING BOSE MUSIC APP USERS**

Add the soundbar to an existing account..... 20  
 Connect to a different Wi-Fi® network..... 20

**ADAPTiQ AUDIO CALIBRATION**

Run ADAPTiQ audio calibration..... 21

**SOUNDBAR CONTROLS**

Remote functions..... 22  
     Power on/off..... 23  
     Auto-wake (optical connection only)..... 23  
     Sources ..... 24  
     Presets ..... 25  
     Media playback and volume..... 26  
 Voice assistant controls..... 27  
 Adjust the audio ..... 27

**VOICE ASSISTANT**

Voice assistant options..... 28

Set up your voice assistant ..... 28

Access Google Assistant..... 29

    Use your voice ..... 29

    Use the soundbar controls..... 30

Play music with Google Assistant ..... 31

    Choose a default audio service..... 31

Access Amazon Alexa..... 32

    Use your voice ..... 32

    Use the soundbar controls..... 33

Calling and Messaging with Amazon Alexa ..... 34

    Set up Alexa Calling and Messaging..... 34

    Use your voice ..... 34

Set up Do Not Disturb ..... 35

    Use your voice ..... 35

Control audio with Voice4Video™ ..... 35

    Set up Voice4Video™ ..... 35

    Use your voice ..... 36

**PRESET PERSONALIZATION**

Set a preset ..... 37

Play a preset ..... 38

**BLUETOOTH® CONNECTIONS**

Connect a mobile device ..... 39

Disconnect a mobile device..... 40

Reconnect a mobile device..... 40

Connect an additional mobile device ..... 40

Clear the soundbar device list..... 40

**STREAM AUDIO WITH AIRPLAY**

Stream audio from the Control Center..... 41  
 Stream audio from an app ..... 41

**SOUNDBAR STATUS**

Wi-Fi status ..... 42  
*Bluetooth* status ..... 42  
 Voice assistant status ..... 43  
     Microphone off light ..... 44  
 Media playback and volume status ..... 44  
 Update and error status ..... 45

**ADVANCED FEATURES**

Disable/enable Wi-Fi capability ..... 46

**CONNECT BOSE PRODUCTS**

Connect accessories (optional)..... 47  
 Connect a Bose SoundLink *Bluetooth* speaker or Bose headphones  
 using SimpleSync™ technology..... 47  
     Benefits..... 47  
     Compatible products ..... 47  
     Connect using the Bose Music app ..... 48  
 Reconnect a Bose SoundLink *Bluetooth* speaker or Bose headphones... 48

**CARE AND MAINTENANCE**

Update the soundbar ..... 49  
 Install the remote batteries..... 49  
 Clean the soundbar ..... 50  
 Replacement parts and accessories..... 50  
 Limited warranty ..... 50

**TROUBLESHOOTING**

Try these solutions first .....	51
Other solutions .....	51
Reset the soundbar .....	59

**APPENDIX: SETUP REFERENCE**

Connection options .....	60
Connect the soundbar to your TV .....	61
Option 1 (preferred): HDMI eARC or ARC .....	61
Option 2: Optical .....	62
Check for sound .....	63

## CONTENTS

Confirm that the following parts are included:



Bose Smart Soundbar 900

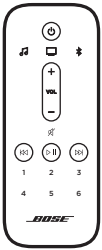

Remote



AAA Battery (2)

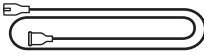

Power cord\*

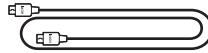

HDMI cable

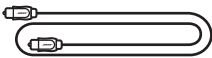

Optical cable



ADAPTiQ headset

\* May ship with multiple power cords. Use the power cord for your region.

**NOTE:** If any part of the product is damaged or if the glass on the soundbar is broken, don't use it. Contact your authorized Bose dealer or Bose customer service.

Visit: [worldwide.Bose.com/Support/SB900](https://www.worldwide.Bose.com/Support/SB900)

The Bose Smart Soundbar 900 supports Dolby Atmos® technology. The soundbar uses additional up-firing speakers to deliver high-quality sound from all directions, achieving a superb, immersive, and fully-encompassing surround-sound experience.

## RECOMMENDATIONS

- Place the soundbar below and in front of the TV (preferred) or above your TV with the front of the soundbar facing into the room.
- For best sound quality, make sure the speakers on top of the soundbar (up-firing speakers) aren't blocked.
- When the soundbar is mounted to the wall, make sure the top of the soundbar is at least 4 in (10 cm) away from the TV.
- If placing the soundbar on a shelf or TV stand, position the front of the soundbar as close as possible to the front edge of the shelf or stand for best sound quality.
- Place the soundbar outside of and away from metal cabinets, other audio/video components, and direct heat sources.
- Place the soundbar on its rubber feet on a stable and level surface. For proper support, both feet must be resting on the surface. Vibration can cause the soundbar to move, particularly on smooth surfaces like marble, glass, or highly polished wood.
- Keep the back side of the soundbar at least 0.4 in (1 cm) from any other surface. Blocking the port(s) on this side affects sound quality.
- Make sure there is an AC (mains) outlet nearby.
- To avoid wireless interference, keep other wireless equipment at least 1 – 3 ft (0.3 – 0.9 m) away from the soundbar.
- To avoid wireless interference, some Wi-Fi access points may need to be placed up to 8 – 10 ft (2.4 – 3.0 m) away from the soundbar, optional bass module, and optional surround speakers.
- For best sound quality, don't place the soundbar in an enclosed cabinet or diagonally in a corner.
- Don't place any objects on top of the soundbar.

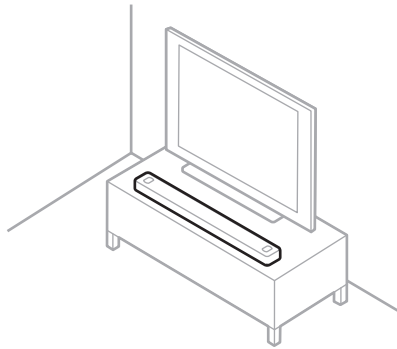

**CAUTION:** Do NOT place the soundbar on its front, back, or top when in use.

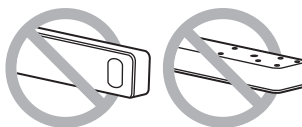



## WALL MOUNT THE SOUNDBAR

You can mount the soundbar on a wall. To purchase the Bose Soundbar Wall Bracket, contact your authorized Bose dealer.

Visit: [worldwide.Bose.com/Support/SB900](http://worldwide.Bose.com/Support/SB900)

**NOTE:** Make sure the top of the soundbar is at least 4 in (10 cm) away from the TV.



**CAUTION:** Do NOT use any other hardware to mount the soundbar.

### Adjust audio for wall mounting

After you mount the soundbar, you must run ADAPTiQ (see page 21).

**NOTE:** If you remove the soundbar from the wall, run ADAPTiQ again.

## CONNECT THE SOUNDBAR TO POWER

1. Connect the power cord to the **POWER** port on the back of the soundbar.
2. Plug the other end of the power cord into an AC (mains) power outlet.

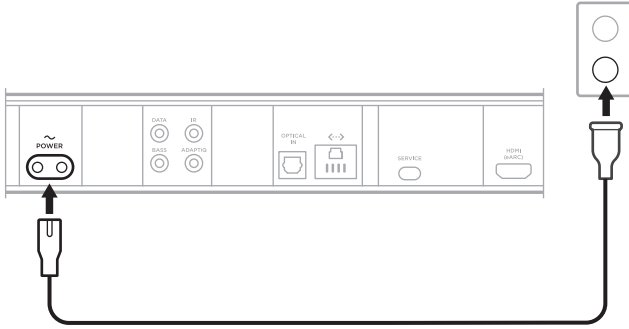



The soundbar powers on, and the light bar glows solid amber.

## NETWORK STANDBY

The soundbar transitions to network standby when audio has stopped and you have not pressed any buttons or talked to your voice assistant for 20 minutes.

To wake the soundbar from network standby:

- On the remote, press the Power button , a source button (see page 24), or the Bose Music button  then a preset button (see page 25).
- Play or resume audio using your mobile device or using the Bose Music app.
- Talk to Google Assistant or Amazon Alexa.

### NOTES:

- To access your voice assistant in network standby, make sure the soundbar has been set up using the Bose Music app (see page 19) and the microphone is on (see page 44).
- You can disable the standby timer using the Bose Music app. You can access this option from the Settings menu.

The Bose Music app lets you set up and control the soundbar from any mobile device, such as a smartphone or tablet.

Using the app, you can stream music, set and change presets, add music services, explore internet radio stations, configure Google Assistant or Amazon Alexa, choose your voice prompt language, manage soundbar settings, and get new features.

**NOTE:** If you have already created a Bose Music account for another Bose product, add the soundbar to your existing account (see page 20).

## DOWNLOAD THE BOSE MUSIC APP

1. On your mobile device, download the Bose Music app.

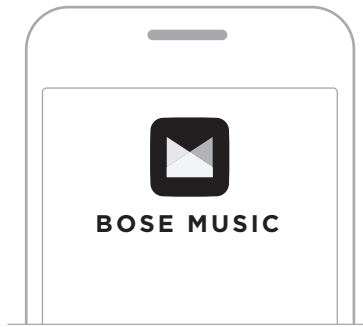



2. Follow the app instructions.

## ADD THE SOUNDBAR TO AN EXISTING ACCOUNT

To add your Bose Smart Soundbar 900, open the Bose Music app and add your soundbar.

## CONNECT TO A DIFFERENT WI-FI NETWORK

Connect to a different network if your network name or password has changed, or if you want to change or add another network.

1. On the remote, press and hold the TV button  and Skip backward button  until the light bar glows amber.
2. On your mobile device, open your Wi-Fi settings.
3. Select **Bose Smart Soundbar 900**.
4. Open the Bose Music app and follow the app instructions.

**NOTE:** If the app doesn't prompt you for setup, go to the main screen and add the soundbar.

After you set up the soundbar using the Bose Music app, the app prompts you to run ADAPTIQ audio calibration for best sound quality. ADAPTIQ audio calibration customizes the sound of the system to the acoustics of your listening area by taking audio measurements at multiple locations in the room. To run an audio calibration, you need 10 minutes when the room is quiet.

During ADAPTIQ audio calibration, a microphone on the top of the ADAPTIQ headset (provided with the soundbar) measures the sound characteristics of your room to determine optimal sound quality.

## **RUN ADAPTIQ AUDIO CALIBRATION**

If you later connect an optional bass module or surround speakers, move the soundbar, or move any furniture, run ADAPTIQ audio calibration again to ensure optimal sound quality.

To run ADAPTIQ audio calibration, use the Bose Music app. You can access this option from the Settings menu.

The soundbar controls are located on the top of the soundbar and on the remote.

**TIP:** You can also control your soundbar using the Bose Music app.

## REMOTE FUNCTIONS

Use the remote to control the soundbar, *Bluetooth* connections, and presets.

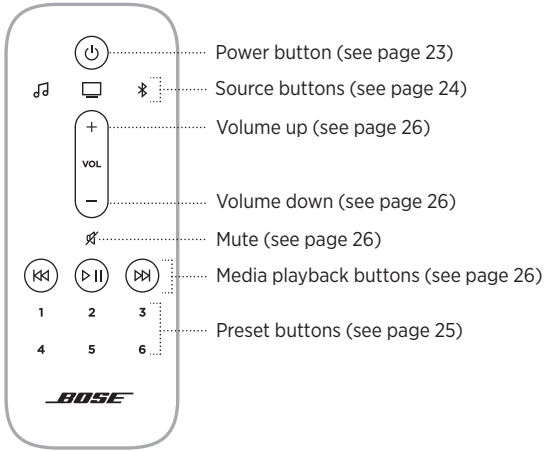

## Power on/off

On the remote, press the Power button  to power the soundbar on/off.

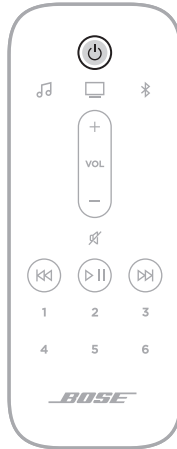

When powered on, the soundbar defaults to the last active source.

### NOTES:

- When you plug the soundbar into an AC (mains) outlet, the soundbar automatically powers on.
- You can still access your voice assistant when the soundbar is powered off.

**TIP:** You can also use Voice4Video™ to power the soundbar on/off (see page 35).

## Auto-wake (optical connection only)

You can set the soundbar to power on whenever a sound signal is received.

To toggle between auto-wake and default power settings, press and hold  for 10 seconds until you hear a tone and the light bar pulses white twice.

**TIP:** You can also control auto-wake using the Bose Music app. You can access this option from the Settings menu.

## Sources

You can control your TV, *Bluetooth* connections, and Bose Music app audio using your remote.

To select a source, press the appropriate button (Bose Music app 🎵, TV 📺, or *Bluetooth* 📶) on the remote.



### TIPS:

- You can also use Voice4Video™ to select your *Bluetooth* source (see page 35).
- You can also use the Bose Music app to select a source.



## Presets

The soundbar includes 6 presets that you can set to play audio from your favorite music services. Once set, you can access your audio, at any time, with a simple touch of a button on the remote or using the Bose Music app.



For more information about presets, see “Preset Personalization” on page 37.



## Media playback and volume



FUNCTION	WHAT TO DO
<b>Play/Pause</b>	<p>Press ▷  .</p> <p><b>NOTES:</b></p> <ul style="list-style-type: none"> <li>When audio is paused, two lights in the center of the light bar glow solid white until audio resumes.</li> <li>You can only play/pause audio when the Bose Music app or a <i>Bluetooth</i> connection is your source.</li> </ul>
<b>Skip forward</b>	Press ▷▷ .
<b>Skip backward</b>	Press ◀◀ .
<b>Volume up</b>	<p>Press +.</p> <p><b>NOTE:</b> To quickly increase the volume, press and hold +.</p>
<b>Volume down</b>	<p>Press —.</p> <p><b>NOTE:</b> To quickly decrease the volume, press and hold —.</p>
<b>Mute/Unmute</b>	<p>Press 🔇.</p> <p>When audio is muted, the left end of the light bar glows solid white until audio resumes.</p> <p><b>TIP:</b> You can also press + to unmute audio.</p>

**TIP:** You can also use Voice4Video™ to control media playback and volume for certain sources (see page 35).

## VOICE ASSISTANT CONTROLS

You can use the Action button  and Microphone off button  to control Google Assistant (see page 29) or Amazon Alexa (see page 32).

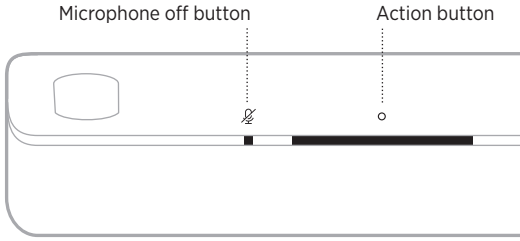

## ADJUST THE AUDIO



To adjust the bass, treble, center channel, and height channel, use the Bose Music app. You can access these options from the Settings menu.

## VOICE ASSISTANT OPTIONS

You can set the soundbar to quickly and easily access Google Assistant or Amazon Alexa.

### NOTE:

- You can't set the soundbar to access Google Assistant and Amazon Alexa at the same time.
- Google Assistant and Amazon Alexa aren't available in certain languages and countries.

PROGRAMMING OPTIONS	HOW TO USE
<b>Google Assistant</b>	Use your voice and/or the Action button  (see page 29).
<b>Amazon Alexa</b>	Use your voice and/or the Action button  (see page 32).

## SET UP YOUR VOICE ASSISTANT

Before you begin, make sure your mobile device and the soundbar are connected to the same Wi-Fi network.

To set up your voice assistant, use the Bose Music app. You can access this option from the Settings menu.

### NOTES:

- When setting up your voice assistant, make sure you use the same audio service account that you used in the Bose Music app.
- If you have multiple Bose Music products in your household, for a seamless voice assistant experience, Bose recommends one person use their Bose Music account and voice assistant account to set up the voice assistant for all Bose Music products.

## ACCESS GOOGLE ASSISTANT

With the soundbar, you can easily enjoy music at home just with your voice. You can play your favorite music, control volume, and find information about the song that you are listening to, hands-free. You can also plan your day, set alarms, and control smart devices around your home – just by using your voice. Just say “Hey Google” or tap the Action button  to talk to Google.

For more information on what Google Assistant can do, visit:  
<https://support.google.com/assistant>

### NOTES:

- Google Assistant isn't available in certain languages and countries.
- For more information about playing music with Google Assistant, see page 31.

## Use your voice





Start with “Hey Google,” then say:

THINGS TO TRY	EXAMPLES OF WHAT TO SAY
Enjoy entertainment	Play some music
Plan your day	What's on my calendar today?
Manage tasks	Set an alarm for 7am tomorrow
Control your smart home	Turn on the lights
Get answers	What's the weather this weekend?

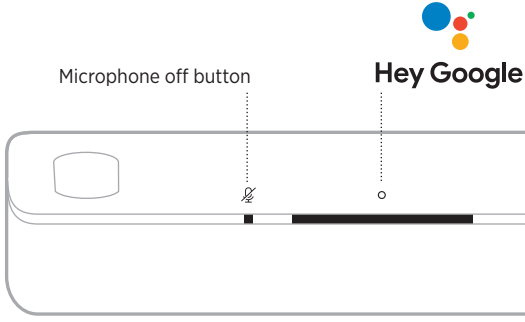
## Use the soundbar controls

You can use the Action button  and Microphone off button  to control Google Assistant. They are located on the top of the soundbar.



THINGS TO TRY	WHAT TO DO
<b>Talk to Google</b>	Tap  then say your request. For a list of things to try, visit: <a href="https://support.google.com/assistant">https://support.google.com/assistant</a>
<b>Stop alarms and timers</b>	Tap  .
<b>Stop Google Assistant</b>	Tap  .
<b>Turn the microphone on/off</b>	Tap  . When the microphone is off, the Microphone off light glows solid red, and you can't access Google Assistant.

## PLAY MUSIC WITH GOOGLE ASSISTANT

Ask Google to play music from your default audio service or from a specific audio service.

Start with “Hey Google,” then say:

THINGS TO TRY	EXAMPLES OF WHAT TO SAY
<b>Play music</b>	Play some music. <b>NOTE:</b> Google Assistant uses your default audio service. To change the default audio service, use the Google Assistant app.
<b>Control your speaker</b>	Turn up the volume.
<b>Play from a specific audio service</b>	Play NPR on TuneIn. <b>NOTE:</b> Google Assistant doesn't support all audio services.
<b>Play on a specific speaker</b>	Play some jazz on the living room speakers. <b>NOTE:</b> Make sure you say the speaker name you assigned in the Bose Music app. If multiple speakers have the same name, use the name assigned in the Google Assistant app or change the name in the Bose Music app.

### Choose a default audio service

During initial setup for Google Assistant, the Google Assistant app prompts you to select a default audio service. When asking Google to play music on Bose products, only Pandora and Spotify are supported default services. Although other audio services are listed as available during setup, they are not supported.

For the best experience, choose Pandora or Spotify as your default audio service. If you choose an unsupported audio service, you hear an error message when requesting to play music.

## ACCESS AMAZON ALEXA

With Alexa on your soundbar, you can simplify your life and use your voice to control your music and much more. Using Alexa is as easy as asking a question. Just ask and Alexa can play your favorite song, skip to the next track, change the volume, read you the news and more. Alexa on your soundbar makes it easier than ever to control your smart home, just by using your voice.

For more information about what Alexa can do, visit:

<https://www.amazon.com/usealexa>

**NOTE:** Alexa isn't available in all languages and countries.

### Use your voice



Start with "Alexa," then say:

THINGS TO TRY	EXAMPLES OF WHAT TO SAY
<b>Talk to Alexa</b>	Help me get started.
<b>Play audio</b>	Play rock music. <b>NOTE:</b> Amazon Music is set as the default music service. To change the default music service, use the Alexa app.
<b>Pause audio</b>	Pause.
<b>Control volume</b>	Turn the volume up.
<b>Skip to the next song</b>	Skip.
<b>Play from a specific audio service</b>	Play NPR on Tunein. <b>NOTE:</b> Amazon Alexa doesn't support all audio services.
<b>Play on a specific speaker</b>	Play jazz in the "Kitchen." <b>NOTE:</b> Make sure you say the speaker name you assigned in the Bose Music app. If multiple speakers have the same name, use the name assigned in the Alexa app or change the name in the Bose Music app.
<b>Set a timer</b>	Set a timer for 15 minutes.





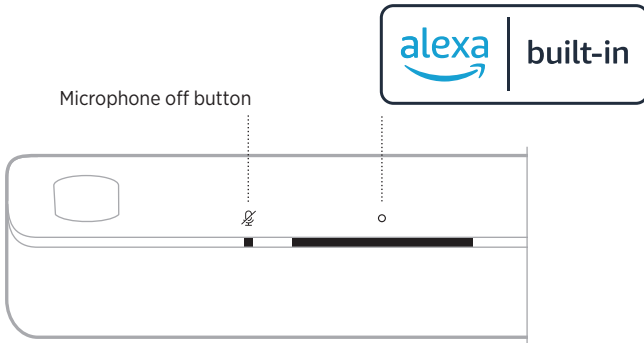

THINGS TO TRY	EXAMPLES OF WHAT TO SAY
<b>Discover more skills</b>	Help me get started with skills.
<b>Stop Alexa</b>	Stop.

### Use the soundbar controls

You can use the Action button  and Microphone off button  to control Amazon Alexa. They are located on the top of the soundbar.



THINGS TO TRY	WHAT TO DO
<b>Talk to Alexa</b>	Tap  then say your request. For a list of things to try, visit: <a href="https://www.amazon.com/usealexa">https://www.amazon.com/usealexa</a>
<b>Stop alarms and timers</b>	Tap  .
<b>Stop Alexa</b>	Tap  .
<b>Turn the microphone on/off</b>	Tap  . <b>NOTE:</b> When the microphone is off, the Microphone off light glows solid red, and you can't access Alexa.

## CALLING AND MESSAGING WITH AMAZON ALEXA

Help your household and family stay better connected. Let Alexa turn your device into an intercom to open up instant two-way conversations between rooms or homes, or send one-way announcements from any room. Use Alexa to call or message almost anyone for free on your supported Alexa device or the Alexa app on your supported mobile phone or tablet.

**NOTE:** Both parties must have an Alexa-enabled device, the Alexa Calling and Messaging feature available and enabled, and given permission to the other party in the Alexa app.

### Set up Alexa Calling and Messaging

To set up Alexa Calling and Messaging, use the Alexa app.

### Use your voice

Start with “Alexa,” then say:

THINGS TO TRY	EXAMPLES OF WHAT TO SAY
<b>Drop in on a device in your home</b>	Drop in on “Kitchen.” <b>NOTE:</b> If the device is a Bose product, make sure you say the speaker name you assigned in the Bose Music app. If multiple speakers have the same name, use the name assigned in the Alexa app or change the name in the Bose Music app.
<b>Drop in on a family member or friend outside your home</b>	Drop in on “Mom’s Kitchen.” <b>NOTE:</b> Make sure you say the speaker name assigned in the owner’s Bose Music app and/or Alexa app.
<b>Make a call</b>	Call Mom.
<b>Answer a call</b>	Answer.
<b>Decline a call or message</b>	Decline.
<b>End a call</b>	End call.
<b>Play a message</b>	Play message.

THINGS TO TRY	EXAMPLES OF WHAT TO SAY
<b>Call an emergency contact</b>	Call my emergency contact.
<b>Make an announcement</b>	Announce that dinner is ready.

## SET UP DO NOT DISTURB

You can temporarily disable all incoming notifications, announcements, and calls to the soundbar.

### Use your voice

Start with “Alexa,” then say:

THINGS TO TRY	EXAMPLES OF WHAT TO SAY
<b>Enable Do Not Disturb</b>	Turn on Do Not Disturb.
<b>Disable Do Not Disturb</b>	Turn off Do Not Disturb.

**TIP:** You can also set up Do Not Disturb using the Alexa app.

## CONTROL AUDIO WITH VOICE4VIDEO™

Bose Voice4Video™ technology expands your Amazon Alexa voice capabilities like no other soundbar can. In addition to controlling your smart soundbar, you can control your TV and cable or satellite box with just your voice. With one simple ask of Alexa, you can turn on your TV and smart soundbar, switch to your video source, tune to a station by network name or channel number, and start watching your favorite shows instantly. Say goodbye to missing remotes and remote tutorials, because Bose Voice4Video™ will make everyone feel like experts — even the babysitter or your tech-troubled in-laws.

### Set up Voice4Video™

To set up Voice4Video™, use the Bose Music app.

**NOTE:** Before setting up Voice4Video™, you must set up Alexa in the Bose Music app (see page 28).

## Use your voice

Start with “Alexa,” then say:

THINGS TO TRY	EXAMPLES OF WHAT TO SAY
<b>Power on TV</b>	Turn on TV.
<b>Power off TV</b>	Turn off TV.
<b>Play video</b>	Play.
<b>Pause video</b>	Pause.
<b>Resume video</b>	Resume.
<b>Skip video forward</b>	Next.
<b>Skip video backward</b>	Previous.
<b>Switch input to <i>Bluetooth</i> audio</b>	Switch to <i>Bluetooth</i> .
<b>Watch a specific network*</b>	Watch NFL Network.
<b>Watch a specific channel number*</b>	Watch channel 802.
<b>Skip to the next channel*</b>	Next channel.
<b>Skip backward to the previous channel*</b>	Previous channel.

\*Only available for cable or satellite boxes.

You can control presets using the Bose Music app or the remote.

**NOTE:** You can't set presets when your source is a *Bluetooth* connection.

## SET A PRESET

1. Stream music using the Bose Music app.
2. On the remote, press the Bose Music button .

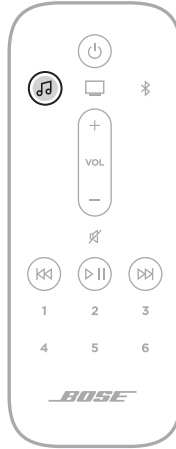

3. Press and hold a preset button until you hear a tone.



## PLAY A PRESET

Once you personalize presets, press a preset button on the remote to play music.



## CONNECT A MOBILE DEVICE

1. On the remote, press the *Bluetooth* button .



The light bar pulses blue.

2. On your mobile device, turn on the *Bluetooth* feature.

**NOTE:** The *Bluetooth* menu is usually found in the Settings menu.

3. Select your soundbar from the device list.

**NOTE:** Look for the name you entered for your soundbar in the Bose Music app. If you didn't name your soundbar, the default name appears.

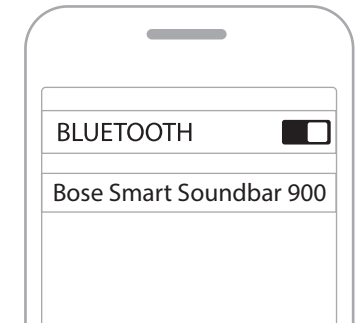

Once connected, you hear a tone, and the light bar glows solid white then fades to black. The soundbar's name appears in the mobile device list.

## DISCONNECT A MOBILE DEVICE

Use the Bose Music app to disconnect your mobile device.

**TIP:** You can also use *Bluetooth* settings on your mobile device. Disabling the *Bluetooth* feature disconnects all other devices.

## RECONNECT A MOBILE DEVICE

On the remote, press the *Bluetooth* button .

The soundbar tries to connect with the most recently-connected devices.

### NOTES:

- Make sure the *Bluetooth* feature is enabled on your mobile device.
- The device must be within 30 ft (9 m) and powered on.

## CONNECT AN ADDITIONAL MOBILE DEVICE

You can store up to eight devices in the soundbar device list.

**NOTE:** You can play audio from only one device at a time.

1. On the remote, press and hold the *Bluetooth* button  until the light bar pulses blue.
2. On your mobile device, select your soundbar from the device list.

**NOTE:** Make sure the *Bluetooth* feature is enabled on your mobile device.

## CLEAR THE SOUNDBAR DEVICE LIST

1. On the remote, press and hold  for 10 seconds until the light bar pulses white twice then fades to black.

The light bar pulses blue.

2. Delete the soundbar from the *Bluetooth* list on your device.

All devices are cleared, and the soundbar is ready to connect (see page 39).



The soundbar is capable of playing AirPlay 2 audio, which allows you to quickly stream audio from your Apple device to the soundbar or multiple speakers.

**NOTES:**

- To use AirPlay 2, you need an Apple device running iOS 11.4 or later.
- Your Apple device and soundbar must be connected to the same Wi-Fi network.
- For more information about AirPlay, visit: <https://www.apple.com/airplay>

## **STREAM AUDIO FROM THE CONTROL CENTER**

1. On your Apple device, open the Control Center.
2. Tap and hold the audio card in the top-right corner of the screen, then tap the AirPlay icon .
3. Select your soundbar.

## **STREAM AUDIO FROM AN APP**

1. Open a music app (like Apple Music), and select a track to play.
2. Tap .
3. Select your soundbar.

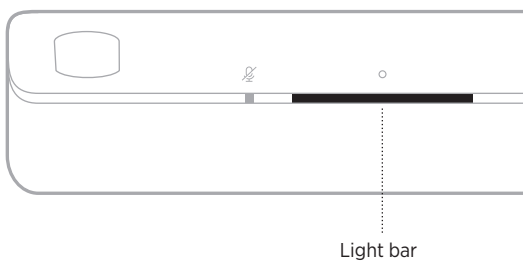

The LED light bar located on the front of the soundbar shows the soundbar status.



**NOTE:** The light bar displays one status at a time of the selected source.





## WI-FI STATUS

Shows the Wi-Fi connection status of the soundbar.

LIGHT BAR ACTIVITY	SYSTEM STATE
<b>Pulsing white</b> 	Connecting to Wi-Fi
<b>Solid white then fades to black</b> 	Connected to Wi-Fi



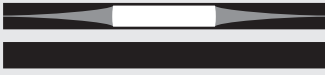



## BLUETOOTH STATUS

Shows the *Bluetooth* connection status of mobile devices.

LIGHT BAR ACTIVITY	SYSTEM STATE
<b>Pulsing blue</b> 	Ready to connect to mobile device
<b>Pulsing white</b> 	Connecting to mobile device
<b>Solid white then fades to black</b> 	Connected to mobile device
<b>White light pulses twice then fades to black</b> 	Clearing device list

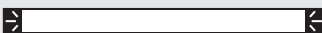
## VOICE ASSISTANT STATUS

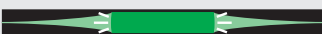
Shows the status of your voice assistant.

LIGHT BAR ACTIVITY	SYSTEM STATE
<b>Off</b> 	Voice assistant is idle
<b>White light slides to the center then glows solid</b> 	Voice assistant is listening
<b>White light slides to the sides</b> 	Voice assistant is thinking
<b>Pulsing white (full)</b> 	Voice assistant is speaking
<b>Pulsing yellow</b> 	Notification from voice assistant
<b>Solid white then white light slides to the sides</b> 	Alert from voice assistant
<b>Pulsing green</b> 	Receiving or making call <b>NOTE:</b> Amazon Alexa only.
<b>Solid green</b> 	Connected to call <b>NOTES:</b> <ul style="list-style-type: none"> <li>When the call is disconnected, the light bar fades to black.</li> <li>Amazon Alexa only.</li> </ul>
<b>Solid purple then fades to black</b> 	Do Not Disturb is enabled <b>NOTES:</b> <ul style="list-style-type: none"> <li>When Do Not Disturb is enabled, the light bar pulses purple each time you try to interact with Alexa.</li> <li>Amazon Alexa only.</li> </ul>

## Microphone off light

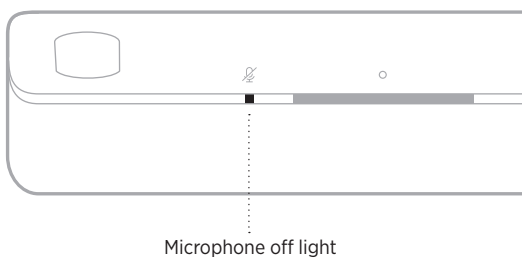

### LIGHT ACTIVITY

### SYSTEM STATE

Solid red

The microphone is off

## MEDIA PLAYBACK AND VOLUME STATUS

Shows the soundbar status when controlling media playback and volume.

### LIGHT BAR ACTIVITY

### SYSTEM STATE

Two center lights glow solid white



Pause

Right end of the light bar pulses white



Volume up

Left end of the light bar pulses white



Volume down







Left end of the light bar glows solid white





Mute

## UPDATE AND ERROR STATUS

Shows the status of software updates and error alerts.

LIGHT BAR ACTIVITY		SYSTEM STATE
<b>Solid amber</b>		Wi-Fi setup in progress
<b>White light slides from right to left</b>		Downloading update
<b>White light slides from left to right</b>		Updating soundbar
<b>Pulses amber 4 times</b>		Source error - refer to the Bose Music app
<b>Pulses red 4 times</b>		Request is temporarily unavailable - try again later
<b>Solid red</b>		Error - contact Bose customer service

## DISABLE/ENABLE WI-FI CAPABILITY

On the remote, press and hold the Bose Music button  and Skip forward button  until the light bar pulses white twice then fades to black.



## CONNECT ACCESSORIES (OPTIONAL)

You can connect any of these accessories to your soundbar. For more information, refer to your accessory owner's guide.

- **Bose Bass Module 700:** [Bose.com/BM700](https://Bose.com/BM700)
- **Bose Bass Module 500:** [Bose.com/BM500](https://Bose.com/BM500)
- **Bose Surround Speakers 700:** [Bose.com/SS700](https://Bose.com/SS700)
- **Bose Surround Speakers:** [Bose.com/SS](https://Bose.com/SS)

## CONNECT A BOSE SOUNDLINK *BLUETOOTH* SPEAKER OR BOSE HEADPHONES USING SIMPLESYNC™ TECHNOLOGY

With Bose SimpleSync™ technology, you can connect certain Bose SoundLink *Bluetooth* speakers or Bose headphones to the soundbar for a new way to hear your music and movies.

### Benefits

- **A personal TV listening experience:** Listen to TV without disturbing others by connecting your Bose headphones to the soundbar. Use independent volume controls on each product to lower or mute the soundbar while keeping your headphones as loud as you like.
- **Another room of audio:** Listen to the same song in two different rooms at the same time by connecting your Bose SoundLink *Bluetooth* speaker to the soundbar.

**NOTE:** SimpleSync™ technology has a *Bluetooth* range of up to 30 ft (9 m). Walls and construction materials can affect reception.

### Compatible products

You can connect most Bose SoundLink *Bluetooth* speakers to the soundbar, as well as Bose headphones.

Popular compatible products include:

- Bose SoundLink Revolve+ *Bluetooth* speaker
- Bose SoundLink Mini *Bluetooth* speaker
- Bose SoundLink Color *Bluetooth* speaker
- Bose Noise Cancelling Headphones 700
- Bose QuietComfort 35 wireless headphones

New products are added periodically. For a complete list and more information, visit: [worldwide.Bose.com/Support/Groups](https://worldwide.Bose.com/Support/Groups)

## Connect using the Bose Music app

To connect your Bose SoundLink *Bluetooth* speaker or Bose headphones to the soundbar, use the Bose Music app. For more information, visit: [worldwide.bose.com/Support/Groups](https://worldwide.bose.com/Support/Groups)

### NOTES:

- Make sure that the product you're connecting is powered on, within 30 ft (9 m) of the soundbar, and ready to connect to another device. For more information, refer to your product owner's guide.
- You can connect only one product at a time to the soundbar.

## RECONNECT A BOSE SOUNDLINK *BLUETOOTH* SPEAKER OR BOSE HEADPHONES

Power on your Bose SoundLink *Bluetooth* speaker or Bose headphones.

Your speaker or headphones try to connect to the most recently-connected *Bluetooth* device, including the soundbar.

### NOTES:

- The soundbar must be within range (30 ft or 9 m) and powered on.
- If your speaker doesn't connect, see "Soundbar doesn't reconnect to a previously-connected Bose SoundLink *Bluetooth* speaker" on page 58.
- If your headphones don't connect, see "Soundbar doesn't reconnect to previously-connected Bose headphones" on page 58.



## UPDATE THE SOUNDBAR

The soundbar updates automatically when connected to the Bose Music app and your Wi-Fi network.

## INSTALL THE REMOTE BATTERIES

1. Slide open the battery compartment cover on the back of the remote.

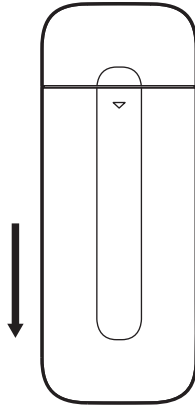

2. Insert the two provided AAA (IEC-LR3) 1.5V batteries. Match the + and – symbols on the batteries with the + and – markings inside the compartment.

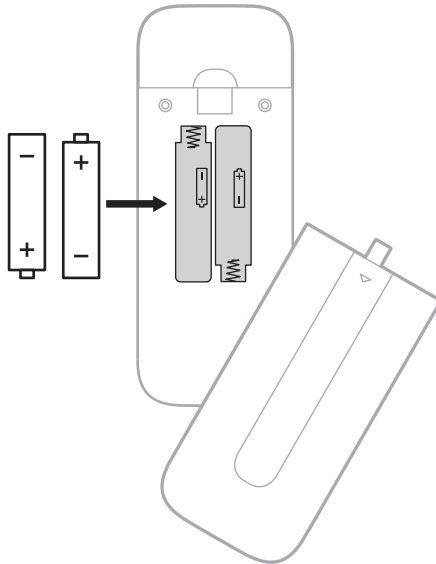

3. Slide the battery compartment cover back into place.

## **CLEAN THE SOUNDBAR**

Wipe the outside surfaces of the soundbar with a soft, dry cloth.

### **CAUTIONS:**

- Do NOT allow liquids to spill onto the soundbar or into any openings.
- Do NOT blow air into the up-firing speakers or soundbar.
- Do NOT use a vacuum to clean the up-firing speakers or soundbar.
- Do NOT use any sprays near the up-firing speakers or soundbar.
- Do NOT use any solvents, chemicals, or cleaning solutions containing alcohol, ammonia, or abrasives.
- Do NOT allow objects to drop into any openings.

## **REPLACEMENT PARTS AND ACCESSORIES**

Replacement parts and accessories can be ordered through Bose customer service.

Visit: [worldwide.bose.com/Support/SB900](https://worldwide.bose.com/Support/SB900)

## **LIMITED WARRANTY**

The soundbar is covered by a limited warranty. Visit our website at [global.bose.com/warranty](https://global.bose.com/warranty) for details of the limited warranty.

To register your product, visit [global.bose.com/register](https://global.bose.com/register) for instructions. Failure to register will not affect your limited warranty rights.

## TRY THESE SOLUTIONS FIRST



If you experience problems with the soundbar:

- Make sure the soundbar is connected to a live AC (mains) outlet.
- Secure all cables.
- Check the state of the soundbar (see page 42).
- Download the Bose Music app and run available software updates.
- Place the soundbar according to the placement guidelines (see page 16).
- Move the soundbar within the recommended range of your mobile device for proper operation.
- Make sure the soundbar is at least 1 – 3 ft (0.3 – 0.9 m) away from wireless equipment.
- Check that any Wi-Fi access points are placed up to 8 – 10 ft (2.4 – 3.0 m) away from the soundbar, optional bass module, and optional surround speakers.

## OTHER SOLUTIONS

If you could not resolve your issue, see the table below to identify symptoms and solutions to common problems. If you are unable to resolve your issue, contact Bose customer service.

Visit: [worldwide.Bose.com/contact](http://worldwide.Bose.com/contact)

SYMPTOM	SOLUTION
<b>No HDMI eARC port on your TV</b>	Use your TV's HDMI ARC port. Use the optical cable to connect the soundbar to your TV.
<b>No HDMI eARC, HDMI ARC, or optical port on your TV</b>	Connect to your TV using an audio converter and separate audio cable, such as a coaxial, 3.5 mm or analog audio cable (not provided). The type of converter and cable you need depends on the audio output ports available on your TV.
<b>Soundbar doesn't power on</b>	Plug the power cord into a different AC (mains) outlet. Use the remote control to power on the soundbar (see page 23). Unplug the power cords for the soundbar and optional bass module or surround speakers, wait 30 seconds, and plug them firmly into a live AC (mains) outlet.
<b>Soundbar doesn't power off</b>	The soundbar may be in network standby mode. On the remote, press the Power button  to wake the soundbar. Press  again to power off the soundbar.

SYMPTOM	SOLUTION
<b>Audio isn't playing in Dolby Atmos</b>	<p>Check the Bose Music app to make sure the audio is streaming in Dolby Atmos. If it's not streaming in Dolby Atmos, make sure the advanced audio settings of your TV is allowing Dolby Atmos to pass through to the soundbar. Refer to your TV owner's guide.</p>
<b>Remote is inconsistent or doesn't work</b>	<p>Match the + and – symbols on the batteries with the + and – markings inside the compartment (see page 49).</p> <p>Replace the batteries (see page 49).</p> <p>Make sure the remote is within operating range (20 ft or 6 m) of the soundbar.</p> <p>Make sure there are no obstructions between the remote and the soundbar.</p>
<b>Intermittent or no audio from soundbar</b>	<p>If the left end of the light bar is glowing solid white, the soundbar is muted. Press the Mute button  to unmute the soundbar.</p> <p>Make sure your mobile device isn't muted.</p> <p>Increase the volume on the soundbar (see page 26) or your mobile device.</p> <p>Switch to a different source (see page 24).</p> <p>Play audio from a different application or music service.</p> <p>If the audio is from a Wi-Fi source, reset the router.</p> <p>Restart your mobile device.</p> <p>Make sure you're using a compatible <i>Bluetooth</i> mobile device.</p> <p>Make sure that the soundbar's HDMI cable is inserted into a port on your TV labeled <b>HDMI eARC</b> (Enhanced Audio Return Channel), not a standard HDMI port. If your TV doesn't have an HDMI eARC port, connect to the HDMI ARC port. If your TV doesn't have an ARC port, connect to the soundbar using the optical cable (see page 62).</p> <p>If the soundbar is connected to your TV's HDMI eARC (or ARC) port, make sure that <b>Consumer Electronics Control (CEC)</b> is enabled in your TV system menu. Your TV may refer to CEC by a different name. Refer to your TV owner's guide.</p> <p>Disconnect the HDMI cable from your TV's HDMI eARC (or ARC) port and reconnect it.</p> <p>Insert the optical cable into a port on your TV labeled <b>Output</b> or <b>OUT</b>, not Input or IN.</p> <p>Unplug the power cords for the soundbar and optional bass module or surround speakers, wait 30 seconds, and plug them firmly into a live AC (mains) outlet.</p> <p>Set CEC to <b>Alternate On</b> using the Bose Music app.</p>

SYMPTOM	SOLUTION
<b>Soundbar doesn't connect to bass module or surround speakers</b>	<p>Refer to your bass module or surround speakers owner's guide for troubleshooting (see page 47).</p> <p>Make sure your bass module or surround speakers are compatible with the soundbar (see page 47).</p> <p>Unplug the power cords for the soundbar and optional bass module or surround speakers, wait 30 seconds, and firmly plug them into the AC (mains) outlet.</p>
<b>No audio from bass module or surround speakers</b>	<p>Make sure your bass module or surround speakers are compatible with the soundbar (see page 47).</p> <p>Make sure the software is current in the Bose Music app.</p> <p>Adjust the bass level using the Bose Music app (see page 27).</p> <p>Switch to a different source (see page 24).</p>
<b>Sound is coming from TV speaker</b>	<p>Make sure that the soundbar's HDMI cable is inserted into a port on your TV labeled <b>HDMI eARC</b> (Enhanced Audio Return Channel), not a standard HDMI port. If your TV doesn't have an HDMI eARC port, connect to the HDMI ARC port. If your TV doesn't have an ARC port, connect to the soundbar using the optical cable (see page 62).</p> <p>Disconnect the HDMI cable from your TV's HDMI eARC (or ARC) port and reconnect it.</p> <p>Unplug the power cords for the soundbar and optional bass module or surround speakers, wait 30 seconds, and firmly plug them into the AC (mains) outlet.</p> <p>Turn off your TV speakers. Refer to your TV owner's guide.</p> <p>Decrease your TV volume to its lowest setting.</p> <p>If the soundbar is connected to your TV's HDMI eARC (or ARC) port, make sure that <b>Consumer Electronics Control (CEC)</b> is enabled in your TV system menu. Your TV may refer to CEC by a different name. Refer to your TV owner's guide.</p> <p>Set CEC to <b>Alternate On</b> using the Bose Music app.</p>
<b>Poor or distorted audio</b>	<p>Test different sources if available.</p> <p>Make sure that your TV can output surround sound audio. Refer to your TV owner's guide.</p> <p>If the audio is being played from another device, reduce the volume of that device.</p> <p>Adjust the bass level using the Bose Music app (see page 27).</p> <p>Power off your TV speakers. Refer to your TV owner's guide.</p> <p>Check for sound (see page 63).</p> <p>Run ADAPTiQ audio calibration (see page 21).</p>

SYMPTOM	SOLUTION
<p><b>Soundbar doesn't play audio from the correct source or selects the incorrect source after a delay</b></p>	<p>Set CEC to <b>Alternate On</b> using the Bose Music app.</p> <p>Disable CEC on your source. Refer to the source owner's guide.</p>
<p><b>Soundbar and source don't power on/off simultaneously</b></p>	<p>On the remote, press the source button for the source that is out of sync.</p> <p>Press the Power button  to power on/off the source.</p>
<p><b>Soundbar doesn't connect to Wi-Fi network</b></p>	<p>In the Bose Music app, select the correct network name, and enter the network password (case-sensitive).</p> <p>Make sure the soundbar and your mobile device are connected to the same Wi-Fi network.</p> <p>If your network information has changed, see page 20.</p> <p>Enable Wi-Fi on the mobile device you are using for setup.</p> <p>Close other open applications on your mobile device.</p> <p>Restart your mobile device and router.</p> <p>If your router supports both 2.4GHz and 5GHz bands, make sure both the device (mobile or computer) and soundbar are connecting to the same band.</p> <p><b>NOTE:</b> Give each band a unique name to make sure you're connecting to the correct band.</p> <p>Reset the router.</p> <p>Unplug the power cords for the soundbar and optional bass module or surround speakers, wait 30 seconds, and firmly plug them into the AC (mains) outlet. Uninstall the Bose Music app on your mobile device, reinstall the app, and restart setup.</p> <p>Connect to the network using an Ethernet cable.</p> <p>If connecting to a different network and the app doesn't prompt you for setup, go to the main screen and add the soundbar.</p>
<p><b>Soundbar doesn't connect with Bluetooth device</b></p>	<p>On your mobile device, turn the <i>Bluetooth</i> feature off and then on. Delete the soundbar from the <i>Bluetooth</i> list. Connect again (see page 39).</p> <p>Connect a different mobile device (see page 40).</p> <p>Make sure you're using a compatible <i>Bluetooth</i> mobile device.</p> <p>Delete the soundbar from your mobile device <i>Bluetooth</i> list. Connect again (see page 39).</p> <p>Clear the soundbar device list (see page 40). Connect again (see page 39).</p>

SYMPTOM	SOLUTION
<b>Soundbar doesn't stream audio using AirPlay</b>	<p>Make sure your soundbar is powered on and in range (see page 23).</p> <p>Make sure your Apple device and your soundbar are connected to the same Wi-Fi network.</p> <p>Update your Apple device.</p> <p>Make sure the soundbar is up-to-date (see page 49).</p> <p>If you can't find the AirPlay icon  in the music app you are streaming from, stream audio from the Control Center.</p> <p>For additional support, visit: <a href="https://www.apple.com/airplay">https://www.apple.com/airplay</a></p>
<b>Bose Music app doesn't work on mobile device</b>	<p>Make sure your mobile device is compatible with the Bose Music app and meets minimum system requirements. For more information, refer to the app store on your mobile device.</p> <p>Uninstall the Bose Music app on your mobile device then reinstall the app (see page 19).</p>
<b>Soundbar isn't visible to add to another Bose account</b>	<p>Make sure sharing is enabled on your soundbar using the Bose Music app.</p> <p>Make sure the soundbar and your mobile device are connected to the same Wi-Fi network.</p>

SYMPTOM	SOLUTION
<p><b>Google Assistant doesn't respond</b></p>	<p>Make sure the Microphone off light isn't glowing red. To turn on the microphone, see page 30.</p> <p>Make sure Google Assistant has been set up using the Bose Music app (see page 28).</p> <p><b>NOTE:</b> The soundbar must be set up and connected to your Wi-Fi network using the Bose Music app. Connect your mobile device to Wi-Fi.</p> <p>Connect your mobile device to Wi-Fi.</p> <p>Make sure you're in a country where Google Assistant is available.</p> <p>Make sure you are using the most up-to-date version of the Google Assistant app.</p> <p>Make sure the wake word is enabled (see page 29).</p> <p>Make sure your mobile device is compatible.</p> <p>Remove Google Assistant from the soundbar using the Bose Music app. Add Google Assistant again.</p> <p>Choose Pandora or Spotify as your default audio service (see page 31).</p> <p>Make sure you use the same audio service account on the Bose Music app and Google Assistant app.</p> <p>Google Assistant may not support your request. New features are added periodically.</p> <p>For additional support, visit:  <a href="https://support.google.com/assistant">https://support.google.com/assistant</a></p>
<p><b>Change Google Assistant personal result settings</b></p>	<p>To turn off personal results or change the account for personal results, use the Settings menu in the Google Assistant app.</p>





SYMPTOM	SOLUTION
<b>Alexa doesn't respond</b>	<p>Make sure the Microphone off light isn't glowing red. To turn on the microphone, see page 33.</p> <p>Make sure Alexa has been set up using the Bose Music app (see page 28).</p> <p><b>NOTE:</b> The soundbar must be set up and connected to your Wi-Fi network using the Bose Music app.</p> <p>Connect your mobile device to Wi-Fi.</p> <p>Make sure you're in a country where Amazon Alexa is available.</p> <p>Make sure you are using the most up-to-date version of the Alexa app.</p> <p>Make sure your mobile device is compatible.</p> <p>Make sure the wake word is enabled (see page 32).</p> <p>Remove Alexa from the soundbar using the Bose Music app. Add Alexa again.</p> <p>Make sure you say the name you assigned in the Bose Music app. If multiple soundbars have the same name, use the name assigned in the Alexa app or change the name in the Bose Music app.</p> <p>If using Voice4Video:</p> <ul style="list-style-type: none"> <li>• Make sure there are no obstructions between the soundbar, your TV, and/or cable or satellite box.</li> <li>• Make sure the soundbar is connected using the HDMI cable (see page 61).</li> <li>• Make sure you have set up this feature using the Bose Music app and connected your TV and/or cable or satellite box.</li> <li>• Make sure you have entered your postal code and service provider for your cable/satellite box.</li> </ul> <p>Alexa may not support your request. New features are added periodically.</p> <p>For additional support, visit: <a href="https://www.amazon.com/usealexa">https://www.amazon.com/usealexa</a></p>
<b>Preset doesn't respond</b>	<p>Make sure the preset has been set (see page 37).</p>
<b>Soundbar doesn't connect to a Bose SoundLink Bluetooth speaker or Bose headphones</b>	<p>Make sure that your speaker or headphones are powered on, within 30 ft (9 m) of the soundbar, and ready to connect to another device. For more information, refer to your product owner's guide.</p>

SYMPTOM	SOLUTION
<b>Soundbar doesn't reconnect to a previously-connected Bose SoundLink <i>Bluetooth</i> speaker</b>	On your speaker, use the product controls to cycle through the product device list until you hear the name for your soundbar. For product-specific instructions, refer to your speaker owner's guide.
<b>Soundbar doesn't reconnect to previously-connected Bose headphones</b>	Connect using the Bose Music app. You can access this option from the Settings menu.
<b>Delayed audio from a connected Bose SoundLink <i>Bluetooth</i> speaker or Bose headphones</b>	<p>Not all Bose SoundLink <i>Bluetooth</i> speakers can play audio in perfect sync when connected to the soundbar. To check if your product is compatible, visit: <a href="https://worldwide.bose.com/Support/Groups">worldwide.bose.com/Support/Groups</a></p> <p>Install any available software updates for your speaker or headphones. To check for updates, open the appropriate Bose app for your product on your mobile device or visit <a href="https://btu.bose.com">btu.bose.com</a> on your computer.</p>

## RESET THE SOUNDBAR

Factory reset clears all source, volume, network, and ADAPTiQ audio calibration settings from the soundbar and returns it to original factory settings.

1. On the remote, press and hold the Power button  and Skip forward button  for 5 seconds until light bar pulses white twice then fades to black.



The soundbar reboots. When the reset is complete, the light bar glows solid amber.

2. To restore the soundbar's network and audio settings:
  - a. Launch the Bose Music app on your mobile device and add the soundbar to your network (see "Add the soundbar to an existing account" on page 20).
  - b. Run ADAPTiQ audio calibration using the Bose Music app (see page 21).

## CONNECTION OPTIONS

Connect the soundbar to your TV using one of the following connection options:

- **Option 1 (preferred):** HDMI eARC (Enhanced Audio Return Channel) or ARC
- **Option 2:** Optical

**NOTE:** Using your TV's HDMI eARC port allows you to use your TV remote to control the power, volume, and mute functions of the soundbar.

1. On the back of your TV, locate the **HDMI IN** and **Audio OUT** (optical) ports.

**NOTE:** Your TV port panel may not appear as shown. Look for the shape of the port.

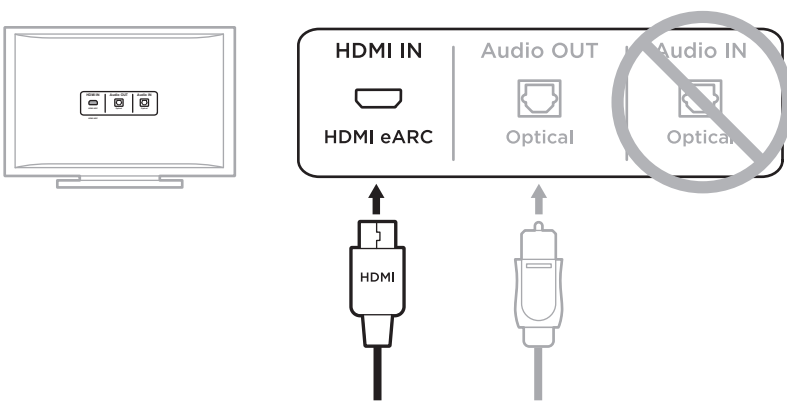

**Option 1 (Preferred)**  
**HDMI eARC (or ARC):** Use the HDMI cable for this connection.

**Option 2**  
**Optical:** If your TV doesn't have an HDMI eARC (or ARC) port, use the optical cable for this connection.

2. Choose an audio cable.

## CONNECT THE SOUNDBAR TO YOUR TV

After choosing an audio cable, connect the soundbar to your TV.

### Option 1 (preferred): HDMI eARC or ARC

1. Insert one end of the HDMI cable into your TV's **HDMI eARC** or **ARC** port.
2. Insert the other end of the cable into the **HDMI (eARC)** port on the soundbar.



## Option 2: Optical

If your TV doesn't have an HDMI eARC (or ARC) port, use the optical cable to connect the soundbar to your TV.

1. Remove the protective cap from both ends of the optical cable.

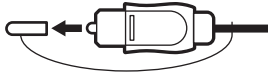

**CAUTION:** Inserting the plug with the cap attached can damage the plug and/or the port.

2. Insert one end of the optical cable into your TV's **Optical OUT** port.

**CAUTION:** Inserting the plug with the wrong orientation can damage the plug and/or the port.

3. Hold the plug at the other end of the optical cable.
4. Align the plug with the soundbar's **OPTICAL IN** port, and insert the plug carefully.

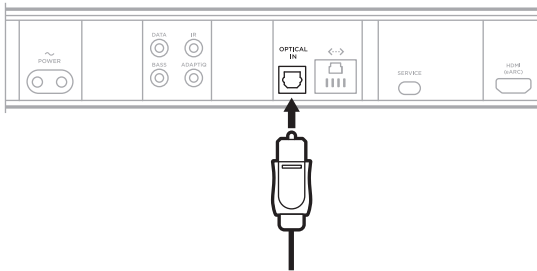

**NOTE:** The port has a hinged door that swings inward when inserting the plug.

5. Firmly push the plug into the port until you hear or feel a click.



## CHECK FOR SOUND

1. Power on your TV.
2. Turn off your TV speakers.

**NOTE:** Refer to your TV owner's guide for more information.

3. If you are using a cable/satellite box or other secondary source:
  - a. Power on this source.
  - b. Select the appropriate TV input.
4. Power on the soundbar (see page 23).

You hear sound coming from the soundbar.

5. On the remote, press the Mute button .

You don't hear sound coming from the TV speakers or soundbar.

**NOTE:** If you hear sound coming from your TV after your soundbar is muted, see "Sound is coming from TV speaker" on page 53.



868287-0010